

**IVECO Daily , Turbodayly**

1990 -> 04/1999



-> 1996  
 FRONT / VOOR / AVANT



**28 10 570**

Kunststoff-Stoßstange grau komplett  
 Plastic bumper grey complete  
 Kunststoff-Stoßstange grau komplett  
 Plastic bumper grijs compleet  
 Pare-choc plastique gris complet

1996 ->  
 FRONT / VOOR / AVANT



**28 12 570**

Kunststoff-Stoßstange grau komplett  
 Plastic bumper grey complete  
 Kunststoff-Stoßstange grau komplett  
 Plastic bumper grijs compleet  
 Pare-choc plastique gris complet

1996 ->



**28 12 667**

Frontverkleidung oben  
 Voorpaneel boven  
 Front panel upper  
 Tôle de calandre supérieure

① Mit / Met / With / Avec LWR



◀▶ **28 12 941**    **28 12 942** ▶  
 ▶▶ **28 12 961**    ① **28 12 962** ▶▶

Scheinwerfer H4  
 Koplamp H4  
 Head lamp H4  
 Projecteur H4

Weiß / Wit / Clear / Blanc



◀▶ **28 12 905**    **28 12 906** ▶

Blinkleuchte komplett  
 Knipperlicht compleet  
 Corner lamp complete  
 Clignoteur complet



◀▶ **28 12 913** ▶▶

Seitliche Blinkleuchte  
 Zijknipperlicht  
 Side lamp  
 Répétiteur latéral

-> 1996



◀▶ **28 10 925**    **28 10 926** ▶

Rückleuchte komplett  
 Achterlicht compleet  
 Tail lamp complete  
 Feu arrière complet

1996 ->

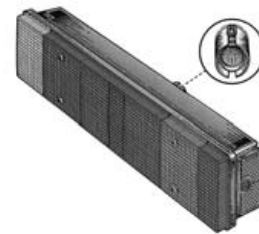

◀▶ **28 12 925**    **28 12 926** ▶

Rückleuchte komplett  
 Achterlicht compleet  
 Tail lamp complete  
 Feu arrière complet

-> 1995 Langer Arm / long arm / lange arm /  
 bras long  
 Hellgrau / Lichtgrijs / Light grey / Gris clair



◀▶ **28 10 811**    Conv/Konvex  
**28 10 812** ▶▶ Conv/Konvex

Spiegel nicht von innen verstellbar  
 Mirror without inner control  
 Spiegel zonder binnenregeling  
 Rétroviseur sans réglage intérieur

1996 -> Kurzer Arm / short arm / korte arm /  
 bras court  
 Dunkelgrau / Donkergrijs / Dark grey / Gris foncé



◀▶ **28 12 801**    Conv/Konvex  
**28 12 802** ▶▶ Conv/Konvex

Spiegel nicht von innen verstellbar  
 Mirror without inner control  
 Spiegel zonder binnenregeling  
 Rétroviseur sans réglage intérieur

1996 -> Langer Arm / long arm / lange arm /  
 bras long  
 Dunkelgrau / Donkergrijs / Dark grey / Gris foncé



◀▶ **28 12 811**    Conv/Konvex  
**28 12 812** ▶▶ Conv/Konvex

Spiegel nicht von innen verstellbar  
 Mirror without inner control  
 Spiegel zonder binnenregeling  
 Rétroviseur sans réglage intérieur

**IVECO Turbodayly**

05/1999 -> 05/2006



+/- Nebelscheinwerferlöcher / Gaten voor mistlampen / Holes for fog lamps / Trous pour phares anti-brouillard  
**FRONT / VOOR / AVANT**



**28 13 570**

Kunststoff-Stoßstange grau  
Plastic bumper grijs

Plastic bumper grey  
Pare-choc plastique gris

-> 08/2004



**28 13 510**

Kühlergrill  
Grille

Grille  
Grille calandre

① Grau / Grey / Grijs / Gris  
② Schwarz / Zwart / Black / Noir  
**HECK / ACHTER / REAR / ARRIERE**



◀▶ **28 13 533** ① **28 13 534** ▶  
◀▶ **28 13 535** ② **28 13 536** ▶

Stoßstange  
Bumper

Bumper  
Pare-choc



◀▶ **28 13 703** ① **28 13 704** ▶  
② **28 13 701**

Motorraumabdeckung unten  
Bescherming onder motor

Cover plate under engine  
Protection sous moteur



**28 13 667**

Frontverkleidung oben  
Voorpaneel boven

Front panel upper  
Tôle de calandre supérieure



**28 13 660**

Motorhaube  
Motorkap

Bonnet  
Capot avant



◀▶ **28 13 655** **28 13 656** ▶

Kotflügel vorne  
Spatbord voor

Front wing  
Aile avant

Mit / Met / With / Avec LWR  
① AL Incl. Motor



◀▶ **28 13 961** **28 13 962** ▶  
◀▶ **28 13 961M** ① **28 13 962M** ▶

Scheinwerfer H1 + H7  
Koplamp H1 + H7

Head lamp H1 + H7  
Projecteur H1 + H7

-> 08/2004



◀▶ **28 13 995** **28 13 996** ▶

Nebelscheinwerfer  
Mistlamp

Fog lamp  
Feu anti-brouillard

Gelb / Geel / Yellow / Jaune

① Komplett / compleet / complete / complet  
② Ohne Fassung / Zonder fitting / Without socket / Sans douille



◀▶ **28 13 901** ① **28 13 902** ▶  
◀▶ **28 13 903** ② **28 13 904** ▶

Blinkleuchte  
Knipperlicht

Corner lamp  
Feu de direction

Weiß / Wit / White / Blanc

① Komplett / compleet / complete / complet  
② Ohne Fassung / Zonder fitting / Without socket / Sans douille



◀▶ **28 13 905** ① **28 13 906** ▶  
◀▶ **28 13 907** ② **28 13 908** ▶

Blinkleuchte  
Knipperlicht

Corner lamp  
Feu de direction

Klein / Small / Petit  
 ① Gelb / Geel / Yellow / Jaune  
 ② Weiß / Wit / Clear / Blanc



◀ 28 13 913 ① 28 13 914 ▶  
 ▶ 28 13 915 ② 28 13 916 ▶

Seitliche Blinkleuchte Side lamp  
 Zijknipperlicht Répétiteur latéral

Groß / Groot / Big / Grand  
 Weiß / Wit / Clear / Blanc



◀ 28 13 917 28 13 918 ▶

Seitliche Blinkleuchte Side lamp  
 Zijknipperlicht Répétiteur latéral

Nicht / Niet / Not / Pas Pritsche / Pick-up  
 Ohne Fassung / Zonder fitting / Without socket /  
 Sans douille



◀ 28 13 931 28 13 932 ▶

Rückleuchte Tail lamp  
 Achterlicht Feu arrière

Pritsche / Pick-up

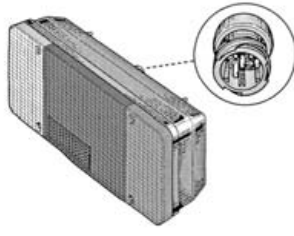

◀ 28 13 925 28 13 926 ▶

Rückleuchte komplett Tail lamp complete  
 Achterlicht compleet Feu arrière complet

Pritsche , Pick-up  
 HECK / ACHTER / REAR / ARRIERE

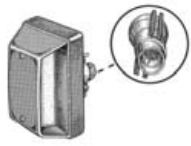

◀ 28 13 919 28 13 920 ▶

Nummernschildleuchte Numberplate light  
 Kentekenplaatverlichting Eclairer de plaque

Kurzer Arm / short arm / korte arm /  
 bras court



◀ 28 13 801 Conv/Konvex  
 28 13 802 ▶ Conv/Konvex

Spiegel nicht von innen verstellbar Mirror without inner control  
 Spiegel zonder binnenregeling Rétroviseur sans réglage intérieur

Mittlerer Arm / medium arm / middel arm /  
 bras moyen



◀ 28 13 811 Conv/Konvex  
 28 13 812 ▶ Conv/Konvex

Spiegel nicht von innen verstellbar Mirror without inner control  
 Spiegel zonder binnenregeling Rétroviseur sans réglage intérieur

Langer Arm / long arm / lange arm /  
 bras long



◀ 28 13 821 Conv/Konvex  
 28 13 822 ▶ Conv/Konvex

Spiegel nicht von innen verstellbar Mirror without inner control  
 Spiegel zonder binnenregeling Rétroviseur sans réglage intérieur

① Beheizbar / Verwarmd / Heated /  
 Chauffant



◀ 28 13 830 ▶  
 ▶ ① 28 13 839 ▶

Spiegelglas Mirror glas  
 Spiegelglas Verre de rétroviseur

**IVECO Turbodayly**  
 05/2006 ->



① Grau / gris / grey / gris  
 ② Oberer Teil grundiert / Bonvenddeel in primer /  
 Upper part primerized /  
 Partie supérieure à peindre  
**FRONT / VOOR / AVANT**



① 28 15 570  
 ② 28 15 572

Kunststoff-Stoßstange Plastic bumper  
 Plastic bumper Pare-choc plastique

① Außen / outer / buiten / extérieur  
 ② Innen / inner / binnen / intérieur



① 28 15 510  
 ② 28 15 513

Kühlergrill Kunststoff Grille plastic  
 Plastic grille Grille calandre plastique

- ① Grau / Grey / Grijs / Gris  
 ② Schwarz / Zwart / Black / Noir  
 HECK / ACHTER / REAR / ARRIERE



◄ 28 13 533 ① 28 13 534 ►  
 ◄ 28 13 535 ② 28 13 536 ►

Stoßstange  
 Bumper

Bumper  
 Pare-choc



28 15 660

Motorhaube  
 Motorkap

Bonnet  
 Capot avant



◄ 28 15 657 28 15 658 ►

Kofflül gel vorne  
 Spatbord voor

Front wing  
 Aile avant

Mit / Met / With / Avec LWR  
 Incl. Motor  
 ① AL



◄ 28 15 961 28 15 962 ►  
 ◄ 28 15 961M ① 28 15 962M ►

Scheinwerfer H1 + H7  
 Koplamp H1 + H7

Head lamp H1 + H7  
 Projecteur H1 + H7

Nicht / Niet / Not / Pas Pritsche , Pick-up



◄ 28 15 931 28 15 932 ►

Rückleuchtenglas  
 Achterlichtglas

Tail lamp glass  
 Verre de feu arrière

Pritsche , Pick-up



◄ 28 15 935 28 15 936 ►

Rückleuchtenglas  
 Achterlichtglas

Tail lamp glass  
 Verre de feu arrière

Kurzer Arm / short arm / korte arm /  
 bras court

Mit Blinkleuchte /  
 Met knipperlicht /  
 With side lamp /  
 Avec répéteur



◄ 28 15 801 Conv/Konv+Sens.Temp  
 28 15 802 ► Conv/Konvex

Spiegel nicht von innen verstellbar

Mirror without inner control

Spiegel zonder binnenregeling

Rétroviseur sans réglage intérieur

Kurzer Arm / short arm / korte arm /  
 bras court

Mit Blinkleuchte /  
 Met knipperlicht /  
 With side lamp /  
 Avec répéteur



◄ 28 15 807 Conv/Konvex  
 28 15 808 ► Conv/Konvex

Spiegel mit elektrischer Verstellung, beheizbar

Mirror with electrical control , heated

Spiegel met elektrische regeling , verwarmd

Rétroviseur avec réglage électrique , chauffant

Langer Arm / long arm / lange arm /  
 bras long

Mit Blinkleuchte /  
 Met knipperlicht /  
 With side lamp /  
 Avec répéteur



◄ 28 15 811 Conv/Konv+Sens.Temp  
 28 15 812 ► Conv/Konvex

Spiegel nicht von innen verstellbar

Mirror without inner control

Spiegel zonder binnenregeling

Rétroviseur sans réglage intérieur

Langer Arm / long arm / lange arm /  
 bras long

Mit Blinkleuchte /  
 Met knipperlicht /  
 With side lamp /  
 Avec répéteur



◄ 28 15 817 Conv/Konvex  
 28 15 818 ► Conv/Konvex

Spiegel mit elektrischer Verstellung, beheizbar

Mirror with electrical control , heated

Spiegel met elektrische regeling , verwarmd

Rétroviseur avec réglage électrique , chauffant